



TIMER ENABLED

Where the PIR is used in conjunction with a Light Symphony Base-Station timer, it is possible to set the PIR to operate at programmed times only, for example Dusk - Midnight (after midnight the PIR is disabled).

1. Set up the PIR as described to trigger the desired Areas and check it functions as required.
2. Set the DIP switch #6 to ON
3. Set up the Base-station's PIR timer function to the required operating time.
4. To test, temporarily advance the Base-station's clock to a time within the PIR's operating window e.g. 22:00.

NOTE:

When using this feature the PIR will transmit only to the Base-Station, which will re-transmit commands to the lighting controller(s). Therefore, ensure the Base-station is in good wireless range of the all PIRs and lighting controllers.

IMPORTANT: WATERPROOFING

Add a continuous bead of silicone grease to the lip of the lid to prevent water ingress. Grease is required on the top and side edges only (do not grease the bottom edge). Also grease under the fixing screw heads.

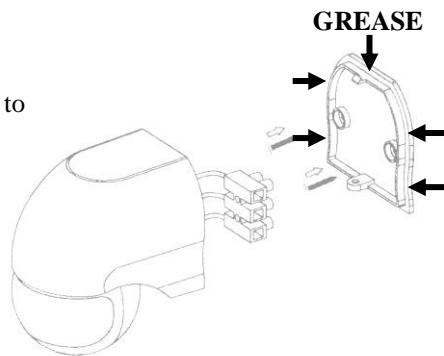

SPECIFICATIONS

Supply	230VAC
Power	1W
Frequency	434.075MHz
Outdoor Rating	IP44
Safety Rating	Double Insulated
Physical	H85mm x W60 mm x D80mm
Ambient Temp.	-20°C to +40°C
Detection Range.	12m / 180° max.

INTRODUCTION

The "Wireless PIR" unit is a mains powered device that uses a long-range wireless transmitter to trigger Light Symphony Lighting Control Modules. The PIR is user-adjustable for On-Times of 1 to 15 minutes. The ambient light level is also easily set using the external adjustment.

When triggered, the unit is factory pre-set to transmit the command; "ALL AREAS ON", which will switch the whole garden on. The PIR can easily be re-programmed to trigger a specific Area or zone from 1 to 29 using the internal DIP Switches. This feature allows multiple PIRs to be used together to control different lighting circuits or groups.

WIRELESS RANGE

The transmit range of the unit is up to 1,000 meters line-of-sight, but this will be reduced by walls and other obstacles.

In all cases, it is strongly recommended that a range-test be carried out before final installation.

If additional range is required a Base-Station or Repeater unit may be installed, these units echo the commands transmitted by the PIR thereby extending its range.

SAFETY INSTRUCTIONS

ELECTRICITY CAN KILL IF IN DOUBT CONSULT A QUALIFIED ELECTRICIAN

This unit must be installed by a qualified electrician adhering to current national electrical installation standards.



Environmental Information for Customers in the European Union

European Directive 2002/96/EC requires that the equipment bearing this symbol on the product and/or its packaging must not be disposed of with unsorted municipal waste. The symbol indicates that this product should be disposed of separately from regular household waste streams. It is your responsibility to dispose of this and other electric and electronic equipment via designated collection facilities appointed by the government or local authorities. Correct disposal and recycling will help prevent potential negative consequences to the environment and human health. For more detailed information about the disposal of your old equipment, please contact your local authorities, waste disposal service, or the shop where you purchased the product.

NOTE:

All rights reserved to change the specification of this product without prior notice.

ELECTRICAL INSTALLATION

The PIR requires an un-switched 1Amp rated mains supply. No earth is required.

The electrical wiring is shown below:

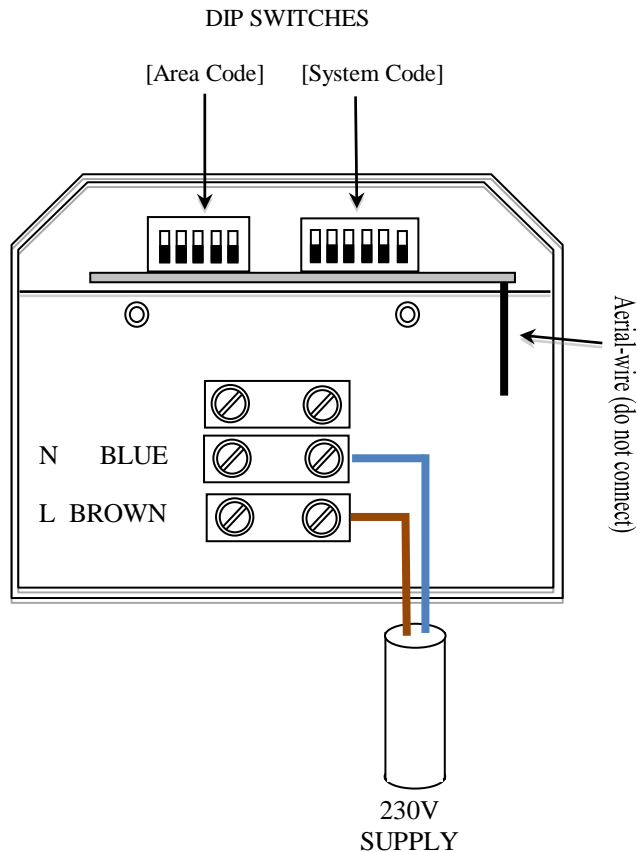

IMPORTANT:

1. Do **NOT** adjust switches while the mains supply is on.
2. Make no connection to the aerial wire or damage may result.

INSTRUCTIONS FOR USE

On the underside of the PIR are two adjustments, set these after installation to suit the location. By adjusting the LUX wheel fully clockwise the PIR will trigger in daylight allowing a walk-test.

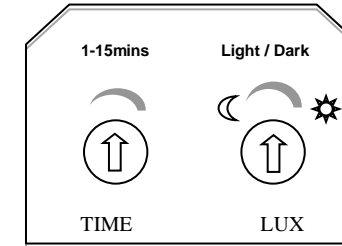

PROGRAMMING

The unit was pre-configured at the factory to trigger the whole garden (ALL AREAS ON) but can easily be re-programmed using the DIP switches. See the enclosed sheet.

1. Ensure the PIR is powered (allow 1 minute to warm up).
2. Use the tables on the insert sheet to set the DIP switches for the required 'System code' and 'Zone/Area' number.

SYSTEM CODE

The 'System Code' is used to prevent interference from neighbouring systems. The unit is factory set to #1, choose a random number from 2-29 and set all devices on your system to the same code.

A few seconds after applying power to the PIR the LED will blink to indicate the System Code set, allowing it be checked without removing the cover. Count the LED blinks, e.g 2 blinks = System Code 2.

AREA (Zone) Code

All Garden

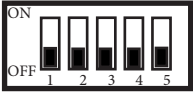

Area Code 1

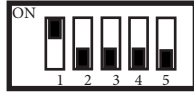

Area Code 2

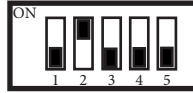

Area Code 3

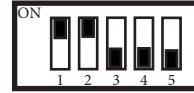

Area Code 4

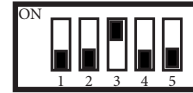

Area Code 5

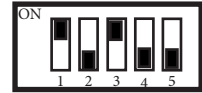

Area Code 6

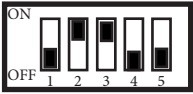

Area Code 7

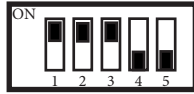

Area Code 8

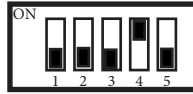

Area Code 9

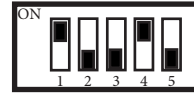

Area Code 10

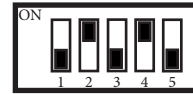

Area Code 11

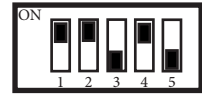

Area Code 12

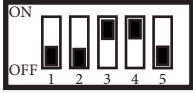

Area Code 13

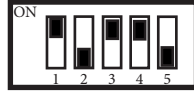

Area Code 14

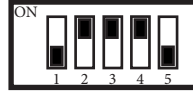

Area Code 15

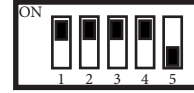

Area Code 16

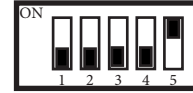

Area Code 17

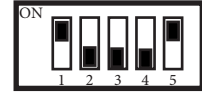

Area Code 18

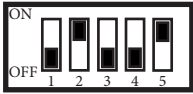

Area Code 19

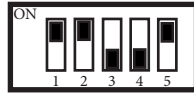

Area Code 20

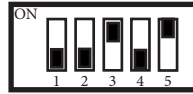

Area Code 21

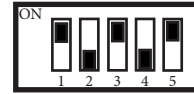

Area Code 22



Area Code 23

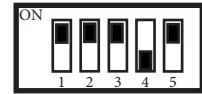

Area Code 24

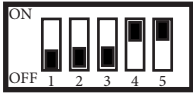

Area Code 25

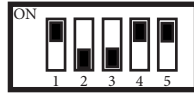

Area Code 26

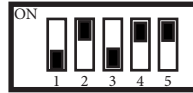

Area Code 27

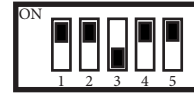



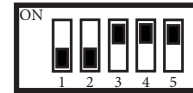



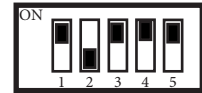

Area Code 28

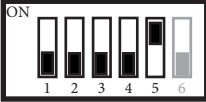
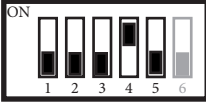
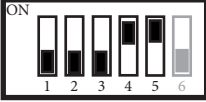
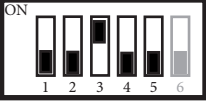
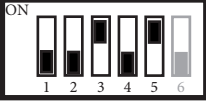
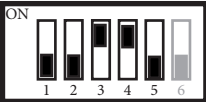
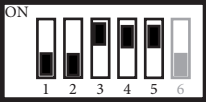
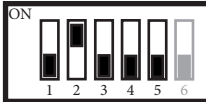
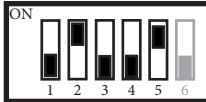
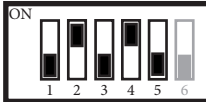
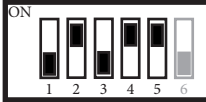

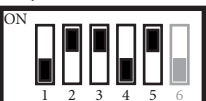
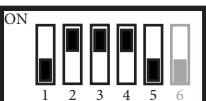
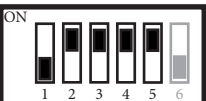
Area Code 29

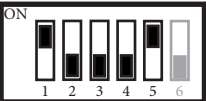
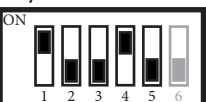
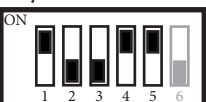
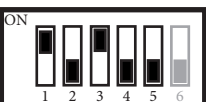
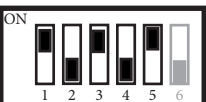

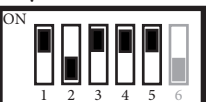
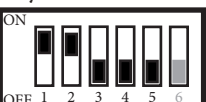
SYSTEM CODE

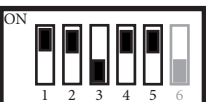
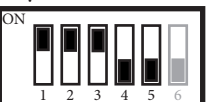
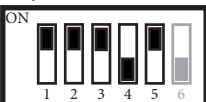
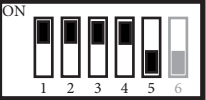
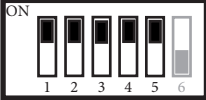
<p>System Code 1</p> 	<p>System Code 2</p> 	<p>System Code 3</p> 	<p>System Code 4</p> 	<p>System Code 5</p> 	<p>System Code 6</p> 
<p>System Code 7</p> 	<p>System Code 8</p> 	<p>System Code 9</p> 	<p>System Code 10</p> 	<p>System Code 11</p> 	<p>System Code 12</p> 
<p>System Code 13</p> 	<p>System Code 14</p> 	<p>System Code 15</p> 	<p>System Code 16</p> 	<p>System Code 17</p> 	<p>System Code 18</p> 
<p>System Code 19</p> 	<p>System Code 20</p> 	<p>System Code 21</p> 	<p>System Code 22</p> 	<p>System Code 23</p> 	<p>System Code 24</p> 
<p>System Code 25</p> 	<p>System Code 26</p> 	<p>System Code 27</p> 	<p>System Code 28</p> 	<p>System Code 29</p> 	<p>System Code 30</p> 
<p>System Code 31</p> 	<p>System Code 32</p> 	<p>TIMER ENABLE</p> <p>When switch #6 is ON (up) the PIR will only be active during the hours programmed at the base-station</p>			<p>TIMER ENABLE</p> 